

TWA-A
for Danfoss RA valves

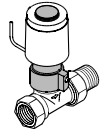

TWA-V
For Danfoss RAV/VMT valves

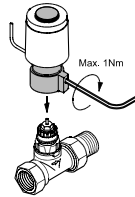
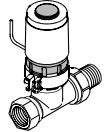
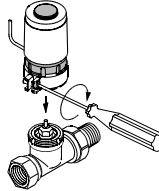

TWA-L
For Danfoss RAVL valves

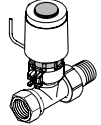
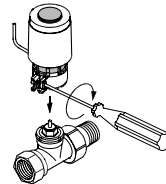

TWA-K
For valves with
Heimeier/MNG/Oventrop
M30 x 1.5 connection

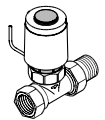
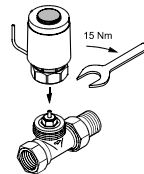

NO

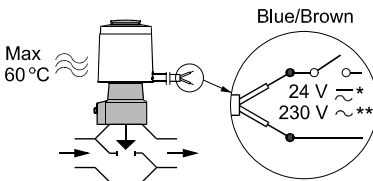

*) 24 V Class II transformer (SELV)
**) 230 V max. 3 A pre-fuse

IP 41

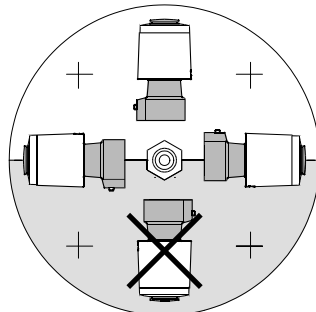



INSTRUCTIONS

TWA NC

088F0248

088F0248

TWA-A
for Danfoss RA valves

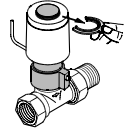
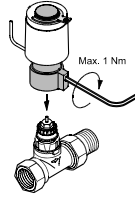

TWA-V
For Danfoss RAV/VMT valves

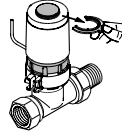
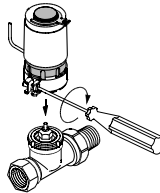

TWA-L
For Danfoss RAVL valves

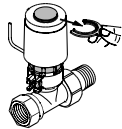
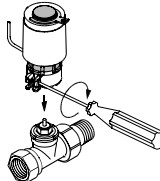

TWA-K
For valves with
Heimeier/MNG/Oventrop
M30 x 1.5 connection

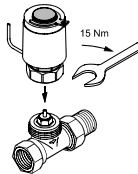

NC

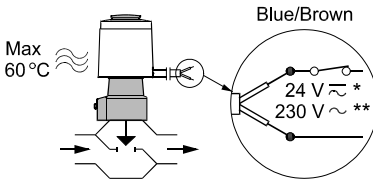

*) 24 V Class II transformer (SELV)
**) 230 V max. 3 A pre-fuse

IP 41

